

SPICE thermal model

BUK7K8R7-40E

Symbol	Parameter	Conditions	Min	Typ	Max	Unit
$R_{th(j-mb)}$	thermal resistance from junction to mounting base		-	-	2.84	K/W

C_{th1}	2.695E-05 F
C_{th2}	1.471E-04 F
C_{th3}	2.047E-04 F
C_{th4}	9.149E-04 F
C_{th5}	3.724E-03 F
C_{th6}	4.432E-03 F
C_{th7}	1.513E-01 F
R_{th1}	3.337E-03 Ω
R_{th2}	7.854E-03 Ω
R_{th3}	4.778E-02 Ω
R_{th4}	1.011E-01 Ω
R_{th5}	3.141E-01 Ω
R_{th6}	1.966E+00 Ω
R_{th7}	4.039E-01 Ω

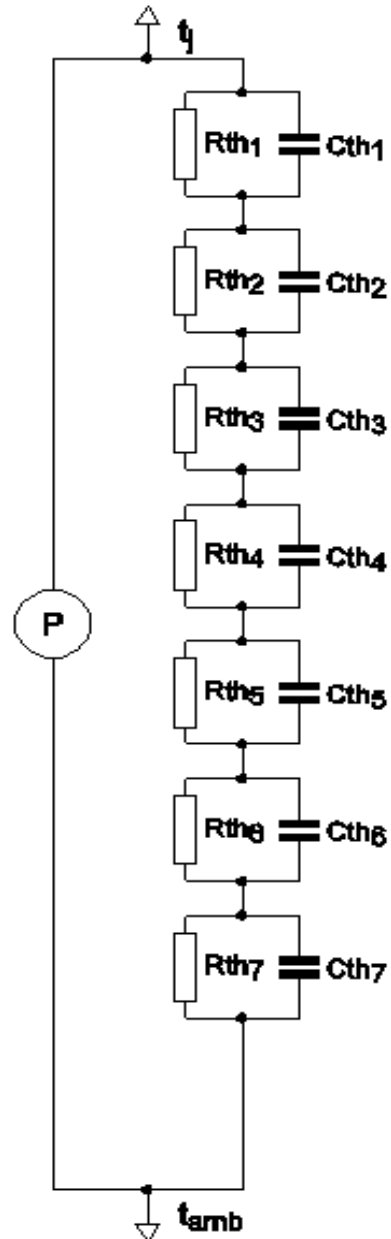

Part: BUK7K8R7-40E
 Date: 20/3/2013
 Rth 2.84 K/W